

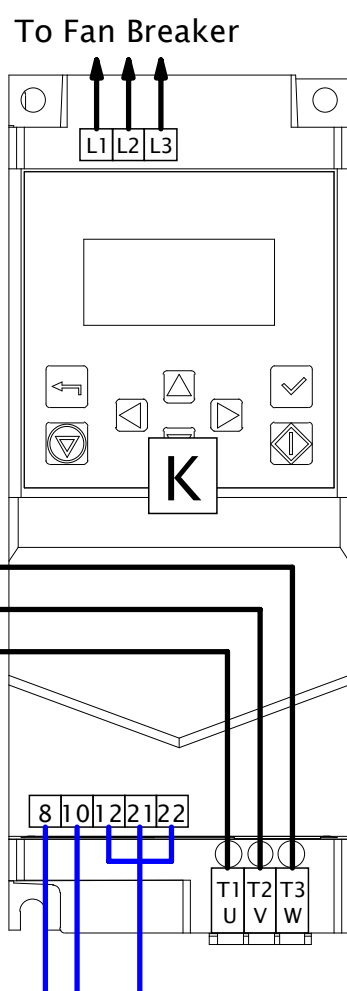

Parts Lists

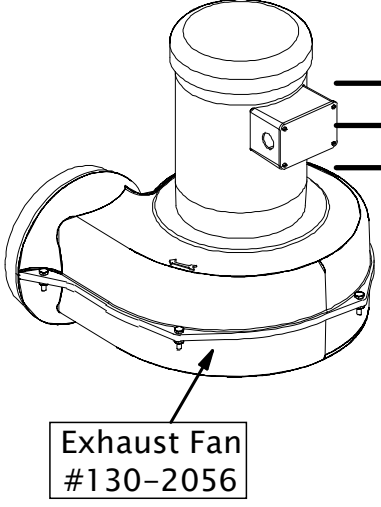

To Fan Breaker

To Wash High Limit Switch

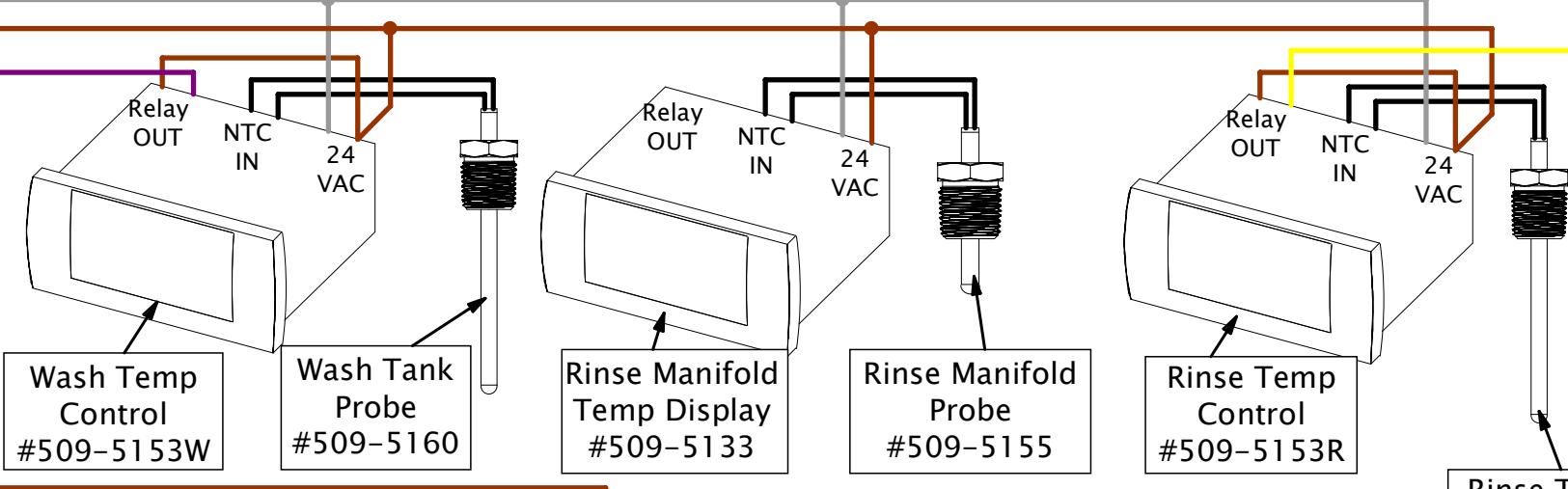

To Rinse High Limit Switch

Line	Common
24VDC	24VAC

External Wires May Vary



Control Panel Ground

T 3 T 4 C H T 1 2

Secondary Fuse

Door Switch #511-5252

Rinse Tank Probe #509-5160

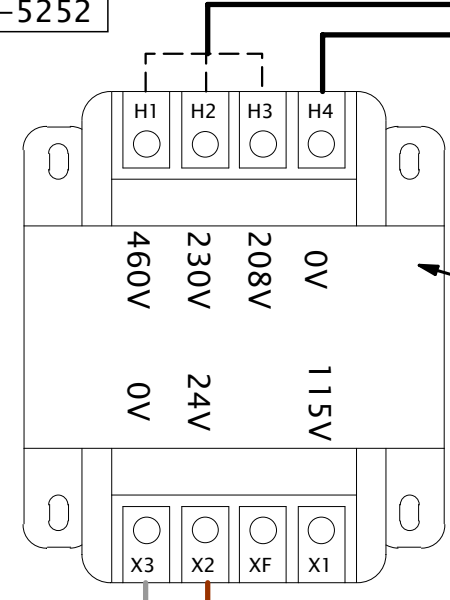

Transformer connection may vary

Transformer #511-5200

Incoming Power Connection

Rinse Light #511-5214

Wash Light #511-5216

Stop Button #511-5269 N.C.

Wash Selector #511-5273 2 N.O.

Start Button #511-5270 N.O.

Power Light #511-5215

Power Switch #511-5272 2 N.O.

Fill Button #511-5271 N.O.

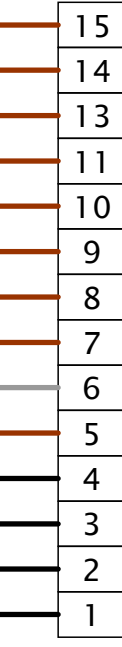

Primary Fuses

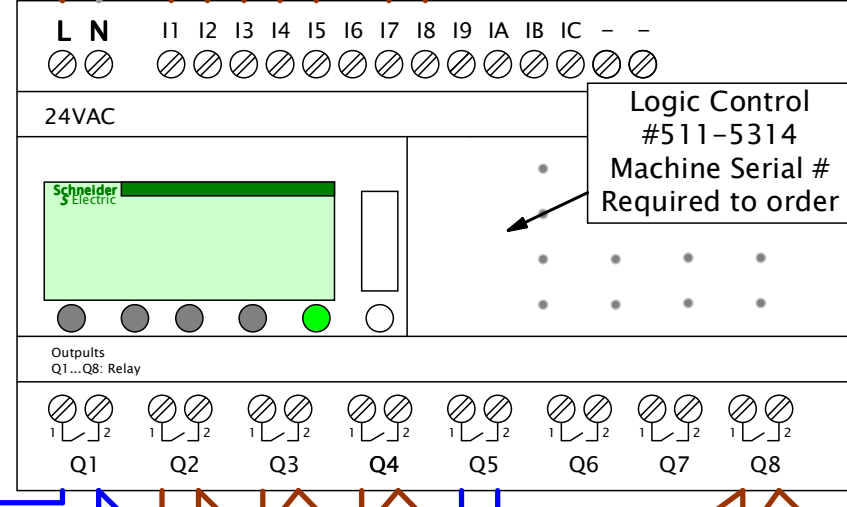

Logic Control #511-5314 Machine Serial # Required to order

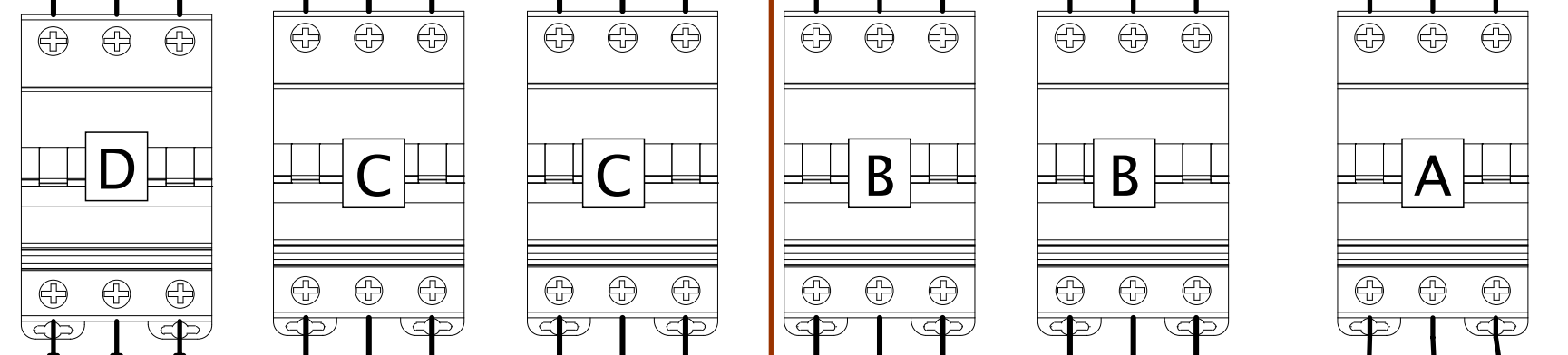

To Fan Drive

Fuse Table		
Voltage	Fuse Rating	Part #
208V/230V Primary	2 Amp	511-5045
460V Primary	1 Amp	511-5157
24V Secondary	6 Amp	511-5377

SOAP 4 1 W R

24VAC for Soap Dispenser

Float Switch #511-5257

To Wash Temp Control

Wash High Limit Switch #509-5132

N.C.

To Rinse Temp Control

Logic Control	
Inputs	Outputs
I1 Float Switch	Q1 Low Speed Fan
I2 Door Switch	Q2 Wash Light
I3 Stop Button	Q3 Pump
I4 Start Button	Q4 Rinse/Fill Solenoid
I5 Light Wash	Q5 Fan
I7 Heavy Wash	Q8 LWCO
I8 Fill Button	

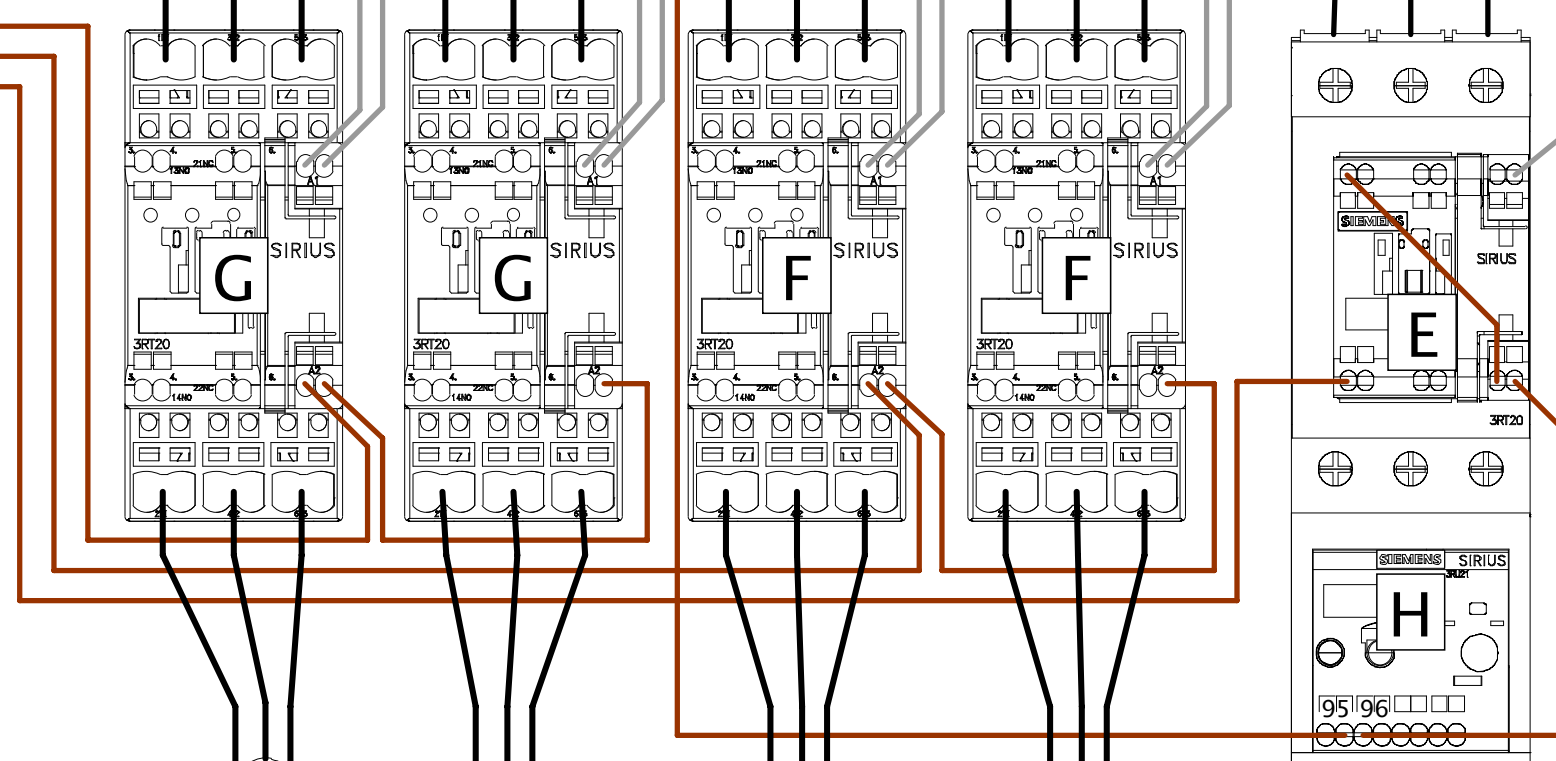

NOT TO SCALE

Wash Pump Motor

ITEM	DESCRIPTION	PART # (208V/230V)	PART # (460V)
A	Pump Breaker	511-5354	511-5344
B	Wash Heat Breaker	511-5347	511-5343
C	Rinse Heat Breaker		
D	Fan Breaker	511-5340	
E	Pump Contactor	511-5297	511-5294
F	Wash Heat Contactor	511-5294	
G	Rinse Heat Contactor	511-5294	
H	Pump Overload	511-5308	511-5305
I	Wash Heating Element	509-5220 (208V)	509-5224
J	Rinse Heating Element	509-5221 (230V)	
K	Fan Drive	511-5355	511-5356



LVO Manufacturing, Inc
808 N 2nd Ave E
Rock Rapids, IA 51246
Phone: (712) 472-3734

Name: FL36 Electric Heat

10/31/2025 A. Lind

Rev. -

No. 124-1325